

Tables of Contents



1. Introduction

- [1.1 About Fortress Power](#)
- [1.2 Data Sheet](#)
- [1.3 Legal Note](#)
- [1.4 General Safety Precautions and Safety Instructions](#)
- [1.5 Transportation and Handling](#)
- [1.6 Storage / Self-Discharge](#)
- [1.7 Response To Emergency Situations](#)
- [1.8 Quick Start Guide](#)
- [1.9 Warranty and Support](#)
- [1.10 System Sizing](#)
- [1.11 Unboxing Check List](#)
- [1.12 UL9540 / UL9540a Fire Test Report](#)

2. Site Selection

- [2.1 Environmental Requirements](#)
- [2.2 Battery Connections](#)
- [2.3 Tools & Materials](#)
- [2.4 Pre-Installation Checklist & Location](#)
- [2.5 Minimum Spacing / UL9540](#)

3. Installation

- [3.1 Mechanical installation Steps](#)
- [3.2 Final Connection of the Installation](#)
- [3.3 LCD Screen and Alarm Warning](#)
- [3.4 RJ485 Communication Cables](#)
- [3.5 Settings the Internal Resistors](#)
- [3.6 Battery ID and Protocol Number](#)
- [3.7 Commissioning the Batteries](#)
- [3.8 Floor Mounting the eVault MAX](#)

4. Operating

[4.1 Charging, Discharging, Programming the Inverter/Charger](#)

[4.2 System Expansion](#)

[4.3 Decommissioning](#)

5. Troubleshooting

[5.1 Serial Number Version Information](#)

[5.2 Diagnostic Guide](#)

[5.3 General Troubleshooting Guide](#)

6. Disassembly

[6.1 Introduction](#)

[6.2 Preliminary Actions](#)

[6.3 Removing Front Panel](#)

[6.4 Removing Dead-Front](#)

7. Servicing

[7.1 Updating Firmware](#)

[7.2 Charging](#)

[7.3 Replacing the Fuse](#)

[7.4 Replacing the BMS](#)

1.1 About Fortress Power

Our mission is to provide compact, user-friendly, and affordable energy storage solutions using the latest technology for all homes and businesses. Fortress solar energy storage batteries can easily integrate with new and existing PV systems and work with a wide range of existing inverter and charge controller manufacturers for ease in system design.

Contact Information

Address:

Corporate Headquarters
505 Keystone Rd, Suite D
Southampton, PA 18966 USA

Website: <https://www.fortresspower.com/>

Phone: (877) 497-6937

1.2 Data Sheet

Electrical

Total Energy (kWh)	18.5
Recommend Charge Current	150
Max. Charge Current (Continuous) [A]	180
Max. Discharge Current Continuous) [A]	180
Max Pulse Current for 10sec [A]	200
Capacity [Ah]	360
Voltage [V]	51.2 (48V Nom)
Charging Temperature [F]	32°F ~ 120°F (0°C ~ 49°C)
Discharging Temperature [F]	14°F ~ 120°F (-10°C ~ 49°C)
Circuit Breaker/Disconnecting Means	250 A
Battery Efficiency	>98%

Mechanical

Dimension [WxDxH in]	20.3 x 20.3 x 42.2
Packaging Dimensions [WxDxH in]	45x24x31
Connection Terminal	M10 or 3/8in
Weight	520lbs (235.87kg)
Enclosure Protection Rating	IP55 (indoor only)
Scalability	Up to 20 units in closed loop communication

1.3 Legal Note

Fortress Power assumes no responsibility or liability for loss or damage, whether direct, indirect, consequential or incidental, which might arise out of the use of this information. Use of this information is entirely at the user's risk. Fortress Power cannot be responsible for system failure, damage, or injury resulting from improper installation of their products. Information included in this document is subject to change without notice.

© 2021 by Fortress Power LLC. All Rights Reserved.
For recycling information please contact Fortress Power



1.4 General Safety Precautions and Safety Instructions

All types of damage to the product may lead to a leakage of electrolyte or flammable gas. During installation of the battery, the utility grid, solar input must be disconnected from the Battery Pack wiring. Wiring must be carried out by qualified personnel. The battery pack contains no user serviceable parts. High voltage or current is present in the device. The electronics inside the Battery Pack are vulnerable to electrostatic discharge. Observe the following precautions:

- Risks of explosion
 - Do not subject the battery pack to strong impacts.
 - Do not crush or puncture the battery pack.
 - Do not dispose of the battery pack in a fire.
- Risks of fire
 - Do not expose the battery pack to temperatures in excess of 122°F (50°C).
 - Do not place the battery pack near a heat source such as a fireplace.
 - Do not expose the battery pack to direct sunlight.
 - Do not allow the battery connectors to touch conductive objects such as wires.
- Risks of electric shock
 - Do not disassemble the battery pack
 - Do not touch the battery pack with wet hands
 - Do not expose the battery pack to moisture or liquids
 - Keep the battery pack away from children and animals.
- Risks of damage to the battery pack
 - Do not allow the battery pack to come in contact with liquids.
 - Do not subject the battery pack to high pressures.
 - Do not place any objects on top of the battery pack.

IMPORTANT NOTE: Circuit Breakers, Disconnects and Fuses should be employed throughout the energy storage and generation installation to isolate effectively and protect all components of the system against faults, short circuits, polarity reversals or a failure of any component in the overall system.

Fuses, breakers, wiring ratings and values should be determined by established standards and evaluated by certified electricians, licensed installers, and regional code authorities. The eVault Max must always be installed and commissioned with settings to protect the batteries from open PV voltage and other high voltage charging sources. The eVault Max Battery Management System (BMS) alone will not protect the batteries from these extreme electrical events. Failure to adhere to installation protocol will void the warranty.



CAUTION! Verify polarity at all connections with a digital voltmeter before energizing the system. Reverse polarity at the battery terminals will void the warranty and destroy the batteries. Do not short circuit the batteries.



Most batteries pose some risk of shock or sparking during the installation and initial wiring and connection process. Wearing insulated gloves, clothing and footwear and using electrically insulated tools are required when working with eVault Max. Cover or remove jewelry or conductive objects (metal bracelets, rings, belt buckles, metal snaps, zippers, etc.) when working with any electrical or mechanical device. Cover or restrain long hair and loose clothing when working with any electrical or mechanical device.

CAUTION! Do not combine the eVault Max with other brands or chemistry; Do not mix eVault Max(s) from different installations, clients, or job sites.



CAUTION! Do not disassemble or modify the battery. If the battery housing is damaged, do not touch exposed contents.

1.5 Transportation and Handling

- Do not knock, drop, puncture, or crush the battery;
- Do not expose battery to flames, incinerate or direct sunlight;
- Do not open battery case or disassemble the battery;
- Do not lift battery by the terminal cables;
- Do not vibrate battery;
- Do not expose battery to water or other fluids;
- Do not expose battery to open flame;
- Do not place the product nearby highly flammable materials, it may lead to fire or explosion in case of accident; Store at cool and dry place.
- Do not store in greenhouses and storage areas for hay, straw, chaff, animal feed, fertilizers, vegetables or fruit products;
- Store the product on a flat surface; A ventilated area is strongly recommended for handling the product;
- Store the product out of reach of children and animals;
- Store the product where it should be minimal dust and dirt in the area; do not transport battery upside down.

1.6 Storage / Self-Discharge

Leaving a system powered on, in operation, is not the same as leaving the system in storage. To store a battery, the battery circuit/BMS should be off. Do not expose battery to high temperatures.

Fortress Lithium Batteries should be stored out of direct sunlight under the following temperature conditions:

Minimum storage temperature		Maximum storage temperature		Storage Duration	Minimum State of Charge
-20°C	-4°F	95°F	35°C	3 Months	50%
-10°C	14°F	95°F	35°C	6 Months	40%
0 - 15°C	32°F – °59F	95°F	35°C	12 Months	20%

Relative Humidity (Min./Max.): 5%~75%

Every 1-3 months:

Systems should be put into storage at 60% SOC and checked to ensure the system SOC does not fall below 20%.

The self-discharge rate of the battery is 1% when powered off and SoC is above 20%.

Power the battery off while in long term storage.

Leaving the BMS powered on results in a faster discharge rate.

Every 6 months:

Cycle the battery every 6 months.

Below 20% SoC:

At 20% SOC, the battery will self-discharge in approximately 2 months.

The self-discharge rate will be even faster if the BMS is powered on.

Note for leaving energized systems unattended for long periods of time:

If leaving the battery unsupervised for long duration, best results require regular use of a charging source. In areas of heavy snowfall, this can include an automatic backup generator. The inverter and battery management system components put a small load on the battery while in operation that can drain the battery if no charging sources are unavailable for long periods of time.

1.7 Response To Emergency Situations

The battery pack consists of multiple batteries and a sophisticated Battery Management System that are designed to prevent hazards resulting from failures. However, Fortress Power cannot guarantee their absolute safety.

- Leaking Batteries

- If the battery pack leaks electrolyte, avoid contact with the leaking liquid or gas. If a person is exposed to the leaked substance, immediately perform the actions described below.

- Inhalation: Evacuate the contaminated area and seek medical attention.

- Contact with eyes: Rinse eyes with flowing water for 15 minutes and seek medical attention.

- Contact with skin: Wash the affected area thoroughly with soap and water, and seek medical attention

- Ingestion: Induce vomiting, and seek medical attention

- Fire

- In case of fire, make sure that an extinguisher is available near the battery pack. If possible, move the battery pack to a safe area before it catches fire.

Note: Fire extinguisher

- Water, carbon dioxide, dry chemical powder and foam are the most effective means to extinguish a Lithium Ferrous Phosphate (LFP) battery fire

- Use ABC Fire extinguisher, if the fire is not from battery and has not spread to it yet.

1.8 QuickStarter Guide

eVault MAX QuickStarter Guide:

<https://learn.fortresspower.com/external/manual/evault-max-quickstart-guide?p=dc8b9a9c1b3f410556835193e66f225757ed23a5e6f1cceaee5fe8270dee1e3c>

1.9 Warranty and Support

Unless otherwise submitting a Fortress warranty through the Guardian hub, please submit your eVault MAX warranty here:

<https://fortresspower.com/warranty>

Beyond this product manual, you may also find our inverter guides useful to system installation and commissioning:

<https://www.fortresspower.com/inverter-guides>

Beyond that, please find additional resources within our Support Portal

<https://support.fortresspower.com/portal/en/kb>

- Create a support ticket
- Inverter Guides
- Product Manuals
- Firmware Updates
- Warranty Submittal
- System Design
- Application Notes
- Scheduled Meetings
- Accessories
- And More!

Note: Sign into the Support Portal to access all features

1.10 System Sizing

Please refer to our sizing guide and warranty letter for appropriate sizes between various inverter models and the eVault MAX.

<https://support.fortresspower.com/portal/en/kb/articles/minimum-battery-sizing>

Instead of memorizing the above chart, a good rule of thumb is a maximum of 9kW of power output per eVault MAX without battery-inverter communication. This restricts the eVault MAX to a C/2 discharge rate, which is good for long battery life regarding normal battery degradation due to both continuous output and <1s burst ratings. Fortress allows rare exceptions to this rule of thumb by allowing the eVault MAX to output up to 12kW in short durations (i.e. 15 minute) on limited inverters, such as the Sol-Ark 15k and LuxPower 12k (both 12kW battery inverters with closed-loop communication to the eVault MAX, with a minimum design ratio of 1:1). However, in those cases, keep in mind the <1s burst capacity of the inverter will be limited in those cases of Fortress-approved battery undersizing, that charging should still be restricted to 9kW, and grid-sellback or demand management features should be restricted to 9kW per eVault MAX.

Design questions can be submitted as support tickets at:

<https://support.fortresspower.com>

1.11 Unboxing Check List

Please confirm and do not discard the following items:

- eVault MAX - eVault MAX communication cable
- eVault MAX - Inverter communication cable (please refer [inverter guides](#) for field making communication cables)
- eVault MAX wall stabilization bracket
- eVault MAX battery terminal caps (positive and negative)
- eVault MAX floor stabilization bracket

1.12 UL9540 / UL9540a Fire Test Report

The eVault MAX has been listed to UL9540 standards as a DC ESS, without any dependency upon an external inverter or power conditioning system. It has passed the UL9540a large-scale fire testing.

Here is a summary taken directly from the test report:

3.10 Performance Summary Remark Against Criteria

Installation level testing is not required as the following performance conditions are met during the unit level test, considered residential Installations and Non-Residential Installations, Indoor Floor Mounted and Outdoor Ground Mounted.

Details see below table,

Performance requirements	Remark	Verdict
a) If flaming outside of the unit observed, separation distances to exposures shall be determine by greatest flame extension observed during test. <i>(No flaming)</i>	No flaming observed in both external and internal of unit during the test.	Pass
b) Surface temperatures of modules within the target units adjacent to the initiating unit do not exceed the temperature at which thermally initiated cell venting occurs. <i>(Surface temperatures of module in the target units do not exceed the temperature at which thermally initiated cell venting occurs)</i>	The maximum surface temperature of module within the initiating unit, adjacent to the initiating module was 94.9 °C; the maximum surface temperature of module within the target unit was 40.9 °C, far below the cell venting temperature 200°C.	Pass
c) For units intended for installation near exposures, surface temperature measurements on wall surfaces do not exceed 97°C of temperature rise above ambient. <i>(Temp. measured on wall 1, wall 2 and unit3 surface close to the unit shall not exceed 97°C+ambient temp.)</i>	Surface temperature rise measurements on wall surfaces and target unit surface adjacent to unit1 was 39.7°C, far below the 97°C.	Pass
d) Explosion hazards are not observed, including deflagration, detonation or accumulation of battery vent gases; <i>(The explosion shall not be observed)</i>	Explosion hazards were not observed in both external and internal of unit, during the test.	Pass
e) Heat flux in the center of the accessible means of egress shall not exceed 1.3kW/m ²	No attributable heat flux detected, see clause 3.5 of this report.	Pass
f) The concentration of flammable gas does not exceed 25% LFL in air for the smallest specified room installation size.	A LFL level of 25% in air not exceeded for smallest room size of 17.5 m ³ . The smallest room size=Total flammable gas/25%LFL =210L/(25%*4.8%) =17500L=17.5m ³	Pass

Please find additional information on the Fortress eVault MAX product page in the Downloads section:

<https://www.fortresspower.com/products/evault-max-18-5kwh-lifepo-battery/>

2.1 Environmental Requirements

Safe and reliable installation of any electrical power system requires knowledgeable and trained technicians. This manual is intended to be a basic guide covering the specifics of the eVault Max unit itself only, due to the variety of systems and components in the field, all possible scenarios cannot be covered. Refer to your professional installers regarding your system and its components and specifications. We encourage you or your installer to contact us with any specific questions for technical support. We are committed to working with you and your installation team to achieve a safe, reliable storage system that will provide years of maintenance free service.

Application scenarios	Residential/Small Commercial
Operating Environment	Indoor and away from strong electromagnetic radiation
Operating Temperature	14°F ~ 120°F (-10°C ~ 49°C)
IP grade	IP55
Storage Temperature	Short Duration (≤ 1 month): -20~45°C (-4~110°F) Long Duration (≥ 1 month): 5~35°C (41~95°F)
Operating Humidity	0 ~ 85% non-condensing
Max charge/discharge current vs. Altitude	180A@ $\leq 2,000$ m 162A@2,000m~4,000m
Case Ground requirement	Use at least 6AWG (16mm ²) copper wire



The eVault Max is designed for parallel operation only - do not arrange in series for increased voltage. Series arrangement can result in damage to eVault Max and will void the warranty!

2.2 Battery Connections

Wire the battery cables and connect them to positive and negative common bus respectively.

For parallel battery connections ensure identical wire lengths and wire type from each eVault Max to the DC combiner.

NOTE: When installing multiple units ensure the recommended spacing distance among units of at least 5inches (12mm).

1. Connect the positive and negative cables from the DC combiner to the inverter.
2. Switch the battery breaker to the "ON" Position
3. Switch the inverter breaker to the "ON" Position



CAUTION! If paralleling the eVault Max 18.5 batteries without connecting them via RJ45 cable(s), please make sure the difference between the highest voltage and lowest voltage does not exceed 0.5 volts. A large current flow from the higher voltage battery to the lower voltage battery and could potentially damage one or both batteries. Resulting damage to the battery will void the warranty.



CAUTION! Verify polarity at all connections with a standard voltmeter before energizing the system. Reverse polarity at the battery terminals will void the warranty and destroy the batteries. Do not short circuit the battery.

2.3 Tools & Materials

The following tools and materials are required:

- Positive and negative battery cables, we recommend copper cable starting at 2/0 AWG for runs of less than 10ft. Please refer to your adopted version of the National Electric Code or Local Authority Having Jurisdiction for more guidance (not included)
- Positive & Negative Terminal Lugs: 3/8in (10mm) (not included) • Electrical Conduit: 1in or 2in (not included)
- Screwdriver (not included) • Battery parallel communications cable (included)
- Inverter to Battery CAT5/5e communications cable (not included)
- Wall Mount Stabilizers (included)
- OSHA approved personal protective equipment such as the following (not included)



Insulated gloves



Safety Glasses



Safety Shoes

2.4 Pre-Installation Checklist & Location

- Check the battery package, type, quantity, appearance and other components for damage and completeness
- Check the battery terminals and connections to make sure they are clean, free of dirt, fluids or corrosion
- All battery cables and their connections should be tight, intact, and NOT broken or frayed
- Check torque on terminal bolts
- Replace any damaged batteries and cables

IMPORTANT NOTE: Please inform us of any problems with the battery within 7 days of receipt of goods. Otherwise, we will deem the product delivered in good condition

The battery pack must be installed indoors. In addition, make sure that the installation location meets the following conditions:

- The area is completely waterproof.
- The floor is flat and level (Inclination < 15°).
- There are no flammable or explosive materials nearby.
- The optimal ambient temperature is within the range from 59° to 95°.
- The temperature and humidity are maintained at a constant level.
- There is minimal dust and dirt in the area. **IMPORTANT NOTE:** If the ambient temperature is outside the operating range, the battery pack may stop operating to protect itself. Frequent exposure to harsh temperatures may deteriorate the performance and life of the battery pack.

2.5 Minimum Spacing / UL9540

UL9540 NOTE: When installing multiple units ensure the minimum required spacing distance between units and walls is 1" per UL9540a large scale fire testing. However, it is recommended to leave at least 5" between eVault MAX units to allow for spacing of conduit bodies. The minimum room size is 17.5 cubic meters.

3.1 Mechanical installation Steps

Mounting and securing the battery

The Fortress eVault Max 18.5 is designed to stand on the floor with the four adjustable support legs on the bottom. The wheels are provided for serviceability only, not intended for stationary installation. We recommend using the wall bracket in high seismic areas. Please refer to the eVault Max Data Sheet for weight and dimensions.

Mounting the battery pack to a wall

1. Fasten the screws through the mounting brackets into the holes of the battery pack on its both sides.
2. Secure the mounting brackets to the wall with screws. Make sure to leave a space of at least 2in in between the battery pack and the wall.

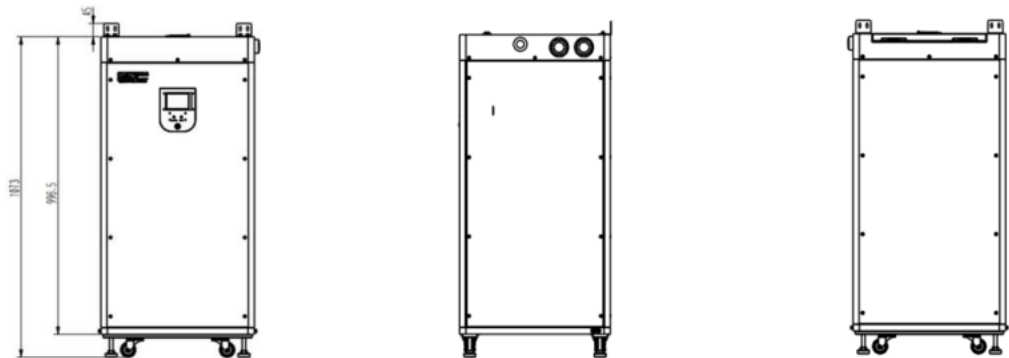

Dimensions are in mm

Connecting the battery to the Charge Controller and/or Hybrid Inverter

The battery terminals are positioned under the top cover. To open the cover, slide the raised latch to the right, the handle will then pop up, rotate it counterclockwise 90° and lift the lid to the open position. Note: the lid does not have a mechanism to keep it from shutting so be sure to open it past 90° or use an object to hold it open.

When connecting the cables ensure that the battery DC breaker is OFF and that the battery screen is off. Pay special attention to the polarity of the connections and do not cross the positive and negative terminals between the inverter/charge controller and the battery; also, ensure the terminals are not connected to any metal mounting point, fixture, or body part.

The eVault Max is equipped with two 3/8s (M10) threaded terminals with a lock washer and nut. Recommended terminal torque is 10.0 –19.1 N·m (7.4 – 14.1 ft.lb) The right-hand terminal is for the positive lead while the left-hand terminal is for the negative. Heavy-duty battery ring terminals of size 3/8s (10mm) along with proper size wiring

cables are required to connect battery to inverter/charger. Do not reverse polarity, doing so will void warranty. Use a voltmeter to check polarity before connecting terminals.

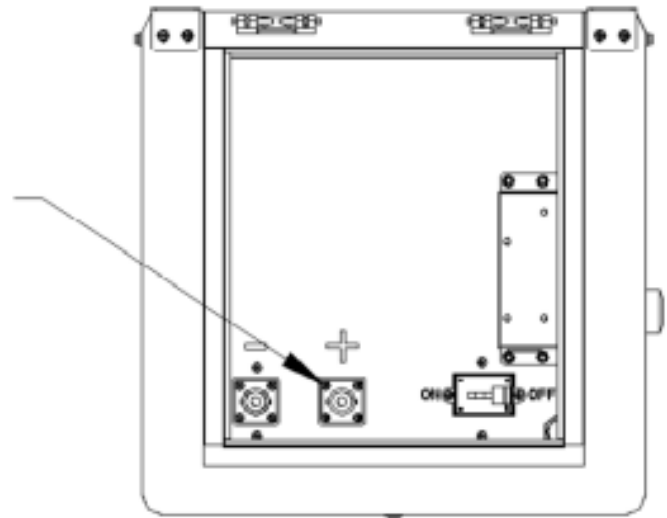

M10 Terminal

Top View

The knockouts are positioned on each side of the battery. The included knockouts are 1in & 2in electrical trade size. There are two on each side of the unit.

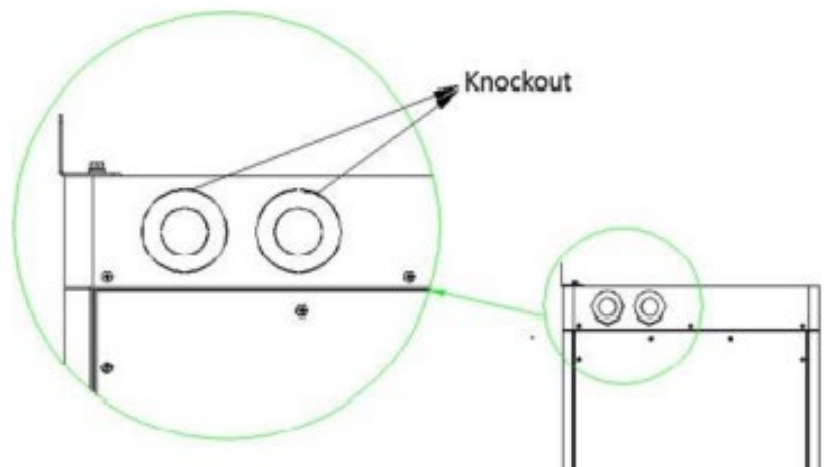

Battery Communications

The eVault Max 18.5 has a self-contained Battery Management System (BMS). No communication is required between a battery-based inverter and the eVault Max 18.5 to operate the system, though closed loop communication is recommended to improve battery and inverter performance.

The Communication Box has five ports next to the battery breaker (refer to communication box picture below). Those ports are designed to support Inverter RS-

485 and CAN communication, battery parallel communication (see section 4.4.6.) and USB Logging.

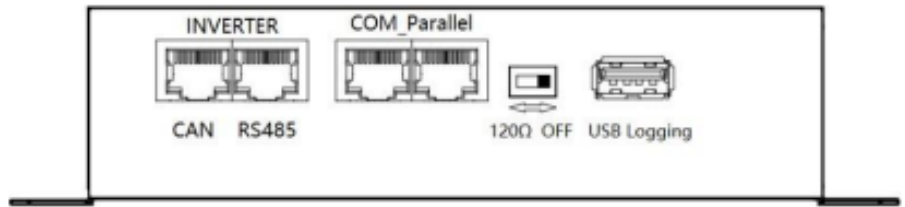

These ports also support MODBUS and CANBUS communication. Please consult with Fortress Technical Support for further assistance.

Grounding

The Fortress eVault Max 18.5 has two grounding lugs on the bottom of battery case.

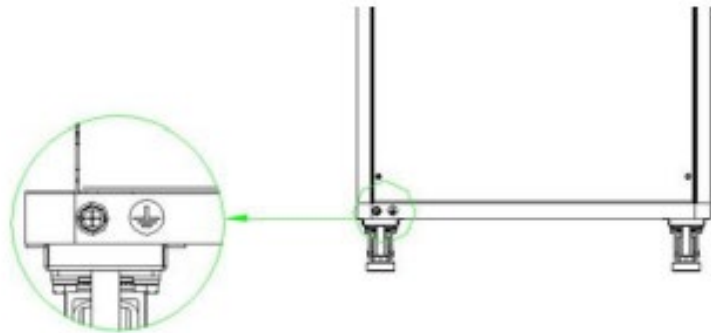

System Commissioning

If you're installing a single eVault Max 18.5, please follow the below steps to start up the system.

1. When using a single battery be sure to set the "Battery ID" to 0 or the unit will not start.
2. Check the DC cables for correct polarity.
3. Switch the battery's 250A breaker to the "ON" position.
4. Switch inverter breaker to the "ON" position.
5. Push the power button on the front of the unit for approximately 8 seconds until the status light and LCD light up.



When installing multiple inverters with one or more eVault Max 18.5, please turn the first inverter on then use the following the steps, then power up the remaining inverters.

Parallel eVault Max Units

eVault Max units with the same capacity may be connected in parallel in configurations of up to 20, this is the maximum number allowed for consistent and robust operation. Quantities greater than this will require consultation with Fortress Power. A qualified installer should understand

the complexities of large-scale storage and must adhere to industry electrical design guidelines, including the NFPA standards and local fire codes when installing systems of this size. The storage capacity and total available current are increased in a parallel arrangement. The following illustration shows how to connect multiple batteries in parallel. Please note that while the overall system voltage is not changed, the available current from the system has been doubled.

1 to 20 eVault Max Parallel Configuration

Closed Loop



Note: For parallel systems maintain identical wire length and wire type from eVault Max to the system battery combiner. When installing more than one eVault Max, a dedicated battery DC combiner is highly recommended. Please see our website for application notes on bus bar selection.



CAUTION! The eVault Max is designed for parallel operation only; series arrangement for higher voltage can result in damage to the eVault Max and will void the warranty.

eVault Max Communication Interface Details

Note: The InverterCAN and RS485 ports are optional and only one is used at a time for closed loop inverter communications. The battery RS484 port is used when the inverter requires a MODBUS interface such as on the Sol-Ark 12, 8, & 5k, as well as the Schneider XW Plus.

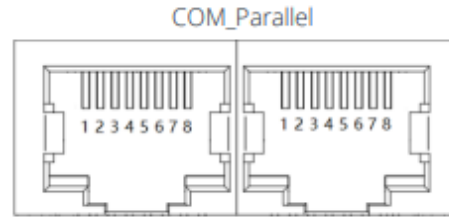
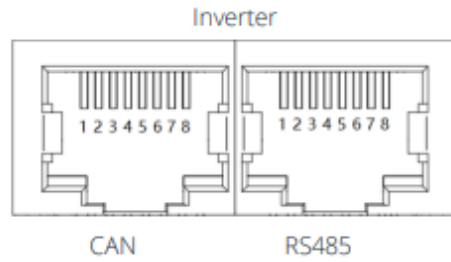

INVERTER CAN PORT

Pin No.	Definition
1.	INVERTER_CANH
2.	INVERTER_CANL
3.	CANGND
4.	NC
5.	NC
6.	NC
7.	NC
8.	NC

INVERTER RS485 PORT

Pin No.	Definition
1.	NC
2.	NC
3.	INVERTER_RS485A
4.	NC
5.	INVERTER_RS485B
6.	RS485GND
7.	NC
8.	NC

**BATTERY
COM_PARALLEL**

Pin No.	Definition
1.	INVERTER_CANH
2.	INVERTER_CANL
3.	CANGND
4.	NC
5.	NC
6.	RS485GND
7.	Parallel_CANL
8.	Parallel_CANH

3.2 Final Connection of the Installation

Final installation and operation guidelines will be dictated by your Electrician and Installer based on the overall properties of and procedures for the equipment in your installation and any code requirements that apply to your region. Fortress Power technicians and sales staff are available to provide any additional information on the eVault Max as needed. Please be aware of the potential electrical hazards before interacting with any and all electrical or mechanical devices. Please take all necessary safety precautions in your projects and installations.

POWERING OFF THE UNIT

If you need to turn off the unit, hold the button below the screen for 8 seconds

3.3 LCD Screen and Alarm Warning

The LCD display on the front of eVault Max provides Battery Voltage (V), Charging and Discharging Current (A), State of Charge (SOC), as well as Charging and Discharging Power Output (kW). Please note, when the battery is charging, the Current (A) will show a negative value, while during the discharging the Current (A) is positive.



The green light (STATUS) indicates system is running properly.

The red alarm light (ALARM) will turn on, if the battery experiences one of those scenarios:

High voltage (HV)

Low voltage (LV)

HighTemperature (HT)

Low Temperature (LT)

Open Circuit (OC)

Short Circuit (SC)

3.4 Communication Protocol and Cables

1. Confirm that each battery DC circuit breaker is in the “OFF” position.
2. Battery-battery communication is done over the COM_Parallel IN and OUT ports. The ports are universal- it does not actually matter which IN/OUT ports you use. If the cable is missing, please use CAT5/5e or greater, 24AWG pure copper, ethernet cables (standard).
3. The inverter communication port depends on whether the Fortress battery uses CANbus or MODbus communication to the inverter.

Schneider / Default	Modbus
SMA / Victron / Sol-Ark	Canbus

3.5 Settings the Internal Resistors

The eVault MAX has internal CANbus resistors, used for battery-battery communication. Ensure the communication matching resistor of the first and last battery is set as 120Ω, while the others are set to OFF.

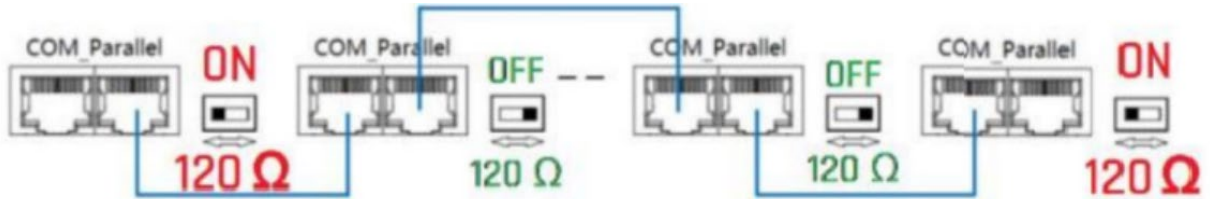

Figure 1

3.6 Battery ID and Protocol Number

Getting Started

The eVault MAX LCD screen is touch responsive. It can receive power and light up from the 48V DC bus even when OFF. Check the battery green STATUS light on the front of the battery. If it is green or blinking green, the battery is on.

Caution - the next steps will turn the batteries on. Complete all wiring and be aware of your surroundings when powering up the batteries.



Program the LCD Screen

1. Press the push-button on the front of each battery for approximately 10 seconds one by one, until the green STATUS light turns on. You should hear each battery "click" on internally.
2. Touch the Battery ID number on the LCD screen to change the number status.

Number of Batteries	Battery ID on LCD Screen
1	0 sets to "master only"
1,2,3,4,5...20	1,2,3,4,5...20

7. Touch the bottom right corner Protocol ID number to set the inverter communication based on the list below:

PROTOCOL ID	SUPPORT INVERTER PROTOCOL
1	Fortress Power MODBUS
2	SMA CANBUS
3	Fortress Power MODBUS
4	Victron CANBUS
5	Schneider MODBUS
6	Sol-Ark CANBUS
7	Reserved
8	Reserved

Turning the batteries on after adjusting the Battery ID or Protocol Number:

1. Turn ON the master inverter breaker, one charge controller, and all DC battery breakers.
2. Turn ON all batteries programmed to the appropriate battery ID or Protocol Number. It is not necessary to turn the batteries OFF if they are on already.
3. Press the push button of master battery (Battery ID 1) for 10+ seconds to turn OFF. Then, press the push button again to turn the battery back ON to start the battery parallel process.
4. After a few seconds, the battery bank will initiate its pre-charge relay to pre-charge the inverter and/or charge controller.
5. The battery relays will then turn on and request charge from the inverter. The batteries will join one by one, based on their voltage levels. All batteries must be within 1/2V of each other.
6. Turn ON any additional inverters or charge controllers.
7. Test the battery bank by charging or discharging the bank to make sure amperage is flowing in or out of every battery.
8. If the batteries are at the same voltage levels, but one battery is showing 0 amps, restart the above steps, this time starting from a complete system power down (power cycling the master battery after powering up the bank).

3.7 Commissioning the Batteries

Note: Recommission the batteries anytime after adjusting the Battery ID or Protocol Number.

Commissioning the batteries:

1. Turn ON the master inverter breaker, one charge controller, and all DC battery breakers.
2. Turn ON all batteries programmed to the appropriate battery ID or Protocol Number. It is not necessary to turn the batteries OFF if they are on already.
3. Press the push button of master battery (Battery ID 1) for 10+ seconds to turn OFF. Then, press the pushbutton again to turn the battery back ON to start the battery parallel process.
4. After a few seconds, the battery bank will initiate its pre-charge relay to pre-charge the inverter and/or charge controller.
5. The battery relays will then turn on and request charge from the inverter. The batteries will join one by one, based on their voltage levels. All batteries must be within 1/2V of each other.
6. Turn ON any additional inverters or charge controllers.
7. Test the battery bank by charging or discharging the bank to make sure amperage is flowing in or out of every battery.
8. If the batteries are at the same voltage levels, but one battery is showing 0 amps, restart the above steps, this time starting from a complete system power down (power cycling the master battery after powering up the bank).

3.8 Floor Mounting the eVault MAX

The eVault MAX has wheels that assist with installation, but is not a portable battery. It is intended to rest on its fixed support legs, using the included wall bracket if additional security is necessary.

Some jurisdictions may have seismic requirements which require bolting the battery to the floor.

The eVault MAX can be mounted directly to floor by replacing the adjustable legs with Pieces of unistrut. Unistrut mounted directly to the eVault MAX frame using M12 x 1.75 bolts into the adjustable legs mount. A second piece of Unistrut or similar material is mounted to the floor that the eVault Frame mounted Unistrut sits on top of and is secured appropriately to the floor.

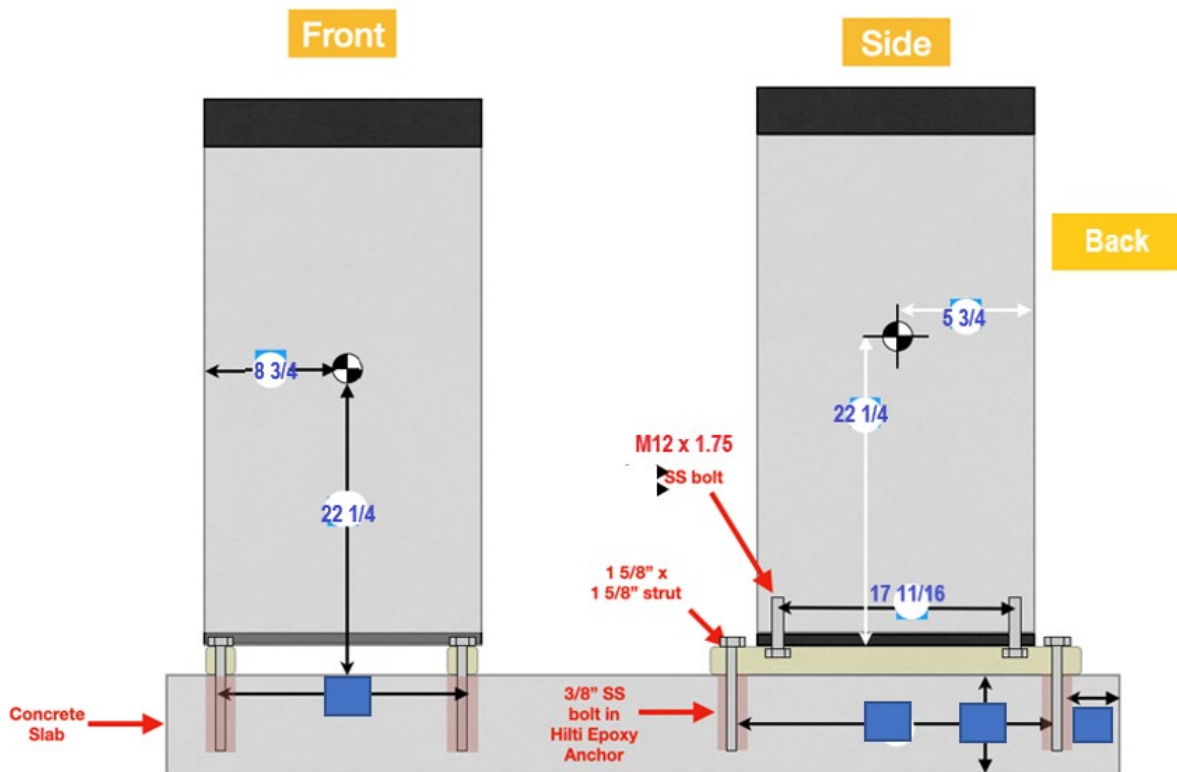

4.1 Charging, Discharging, Programming the Inverter/Charger

OPERATING ENVIRONMENT

See “Product Introduction: Technical Data” Table

CHARGING

Never attempt to charge a battery without first reviewing and understanding the instructions for the charger being used. Only use a Fortress Power Approved Lithium Ferro Phosphate (LFP) charger if ancillary charging is required before installation, testing or troubleshooting. Failure to use a Fortress Power approved LFP charger will damage the battery and void the warranty.



CAUTION! Do not attempt to charge the battery below 32°F (0°C). Attempts to charge at subfreezing temperatures can adversely affect State of Health (SOC) and cycle life and will void the warranty; never charge battery if it is frozen; never charge a visibly damaged battery.

Charging Stage

Please follow the following steps to use the charger to charge the battery:

1. Connect the charger leads to the battery.
2. Make sure that the charger lead, both at the charger and the battery side, connections are tight.
3. Turn the charger on.

NOTE: Recommended charging current is 150A, Max. 180A

DISCHARGING

- Do not discharge battery below operating voltage.
- Do not discharge battery at rates greater than maximum continuous current.
- Do not operate in conditions that will exceed the internal operating temperatures of the battery.

PROGRAMMING THE INVERTER/CHARGER

Before commissioning the energy storage system, the appropriate controller and inverter settings must be programmed per the manufacturer’s recommendations. Consult the manufacturer’s manuals and/or access technical support (Schneider, Sol-Ark, SMA, Magnum, Darfon, Outback).

Although the eVault Max can perform at very high rates and depths of discharge within a very wide temperature range, in order to achieve extended life cycles and to comply with the Warranty, the following guidelines should be followed:

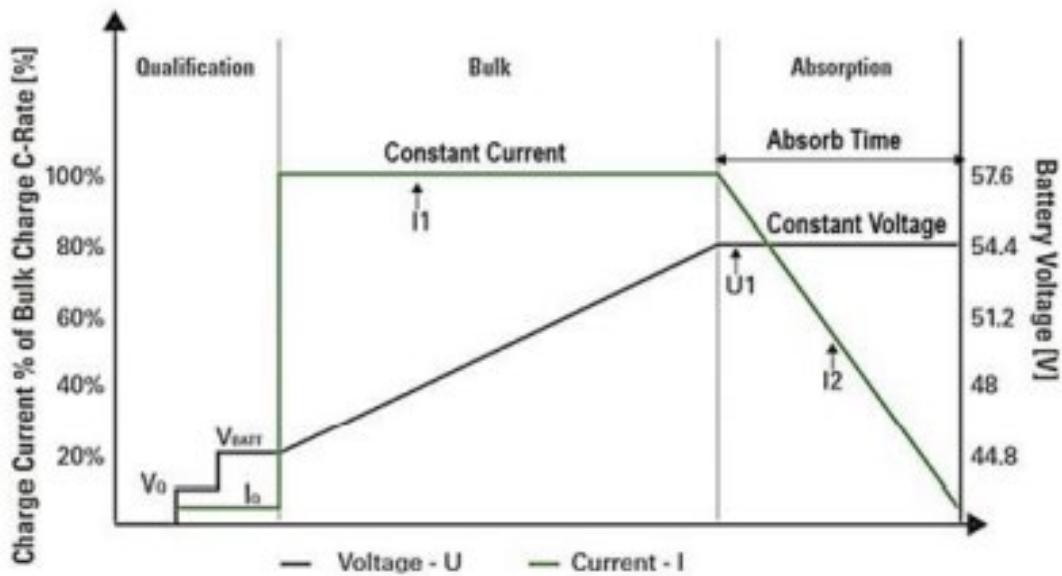

Understand Charge Stage

1. Bulk Charge: Charge at Constant Current (CC) to Bulk/Absorb Voltage
2. Absorption Charge: Maintain Constant Bulk/ Absorb Voltage (CV)
3. Terminate when charge current drops below 0.05C
4. Unlike Lead Acid batteries, Lithium Ferro Phosphate batteries do not require Float Charge

INVERTER/CHARGER CONFIGURATION:

A PDF manual with settings for SMA, Sol-Ark, Schneider, Outback and other Inverters/Chargers is available for download at our website.

For a detailed breakdown of operating conditions and how they can affect battery life and the 10 (5) year battery warranty please see the eVault Max Warranty document on our website.



CAUTION! Do Not Operate the eVault Max at an average temperature exceeding 30°C / 86°F over the life of the battery.

4.2 System Expansion

The eVault Max BMS provides multiple levels protection function:

- **Over Charge Voltage Protection**
- **Over Discharge Protection**
- **Over Current Protection for Discharge Via Thermal Control**
- **Short Circuit Protection**
- **ON/OFF Switch**

In the event of a fault the battery protection circuit will open its internal relays disconnecting the negative battery terminals from the internal cells. The battery uses relays and precautions should be taken to reduce voltage spikes and large inductance in the application.

Over Voltage Fault $58.4\pm 0.4V$

Over Voltage Recovery $54.0\pm 0.4V$

Low Voltage Fault $43.2\pm 0.4V$

Low Voltage Recovery $43.2\pm 0.4V$

When an Incident occurs or an alarm light is on, please follow this guide as the initial step in the troubleshooting process.

1. Please isolate the battery:
 - a. Turn OFF main DC breaker on top of the battery
 - b. Remove all external power sources to/from battery
 2. Make sure Battery Voltage is consistent with LCD Display:
 - a. Turn ON main DC breaker on top of the battery
 - b. Use an available Multimeter to measure the voltage at top of the terminals i. If consistent with LCD Display, please measure the voltage of each battery cell
 - Please see Restart BMS by pushing the POWER Button for at least 10s
 - If Alarm Light persists, see “Measure Cell Voltages Manual” in order to remove the back case of the unit and measure each of its cell voltages
- Note: If inconsistent, please use the BMS Adapter Cable along with BMS Tool Software**
- Once the BMS Tool Software is running, check what Alarm is currently active
 - Follow “Troubleshooting Manual”
3. If the problem persists, please contact Fortress Power Tech Support

4.3 Decommissioning

At the End of Cycle Life retained capacity is equivalent to 70% Year 1 Capacity.

eVault MAX contains scrap material useful to recycling.

Dispose of the battery at a local recycling center or ship back to Fortress Power.

Transport end-of-life batteries at 30% state-of-charge, <52V resting.

5.1 Serial Number Version Information

eVault MAX

Serial Numbers	Shipped Firmware	BMS Version	Important Notes
2101XX	1608	Rev0	Inspect for Battery->BMS connector compatibility if BMS swap is needed. Needs firmware update for power cycle issue.
210505XX-210520XX	1617	RevA	Needs firmware update for power cycle issue.
210621XX	1217	RevA	Knockouts changed to accommodate IP54, starting point for USB for debugging, 12+ battery banks, closed loop with solark, SMA, Solark
2109- 21112318B2265	1218	RevA	closed loop with Victron. "BMS flashing 6 times with normal function error" appears
21112318B2XX	121B17	RevA	BMS flashing 6 times solved
21112318B3XX	121C01	RevA	closed loop with schneider







5.2 Diagnostic Guide

Adding new eVault Max batteries to an existing system (older than 1yr) is not recommended. Like all other batteries, the eVault Max open circuit voltage and internal resistance can change with age. Parallel batteries with different internal resistance may cause reverse currents, which could damage the batteries



5.3 General Troubleshooting Guide

ISSUE	SOLUTION
Unit voltage at terminals is extremely low or is bleeding down (steep decline)	Unit's BMS is in Protection Mode. There are two possible solutions. <ol style="list-style-type: none">1. Use a 48V charger to trickle charge the battery in order activate the BMS2. Use the BMS-to-Computer Adapter Cable in conjunction with the BMS Tool Software on a Windows Computer to forcibly reset the Charge/Discharge Relays. Contact Fortress Power Tech Support.
Unit can charge/ discharge healthily but amperage on LCD Display is not accurate	Check amperage on cable with a Clamp Sensor. If consistent with inverter, but not battery, use the BMS-to-Computer Adapter Cable in conjunction with the BMS Tool on a Windows Computer to check BMS Vitals and diagnose situation. If nothing is seen, BMS Tray may need to be taken out. Inspect Main BMS Module for improper solders or burns. Replace if necessary. Contact Fortress Power Tech Support.
"ALARM" LED Light is on but unit still functions	Check Inverter Settings. Use the BMS-to-Computer Adapter Cable in conjunction with the BMS Tool on a Windows Computer to check BMS Vitals and diagnose situation. Follow the below chart (Section 8.2) for solution
"ALARM" LED Light is on but unit cannot function	Try to turn on unit by holding the Power Button. Use the BMS-to-Computer Adapter Cable in conjunction with the BMS Tool on a Windows Computer to check BMS Vitals and diagnose situation. Follow the below chart for solution. Follow the below chart (Section 8.2) for solution
If cells are imbalanced (upon checking with the BMS Tool)	Open Back case and check harness connections are connected properly. Make sure all connections have "Black" wires on the left side (regardless of orientation) and "Red" on the right side. Check voltages of each cell (See "Measure Cell Voltages Manual")
LCD Display went Dark	LCD Display will automatically go dark after 60 seconds of inactivity to preserve energy consumption. If problem persists, open front case and check LCD Display connections.
Whole system (Inverter and Battery) shut off	Check Breaker to see if tripped. Set Breaker to "Off" then turn back to "On". Reset Battery BMS. Try to restart battery by holding down the Power Button. If problem persists, use the BMS-to-Computer Adapter Cable in conjunction with the BMS Tool on a Windows Computer to check BMS Vitals and diagnose situation.





ERROR LIST

	over high voltage protection
	over low voltage protection
	Discharge over-temp protection, charge over-temp protection, environmental over-temp protection
	Discharge low-temp protection, charging low-temp protection, environmental low-temp protection
	Discharge over current protection, charge over current protection
	Short circuit protection

FUNDAMENTAL TROUBLESHOOTING GUIDE

RUNNING STATE	STATUS	RUN	ALM	DISPLAY	SOLUTION
	normal	•	-	- -	
	Battery COM Error		-	Flash -	Check the communication cable and battery ID (Cannot repeat with others) on LCD, then restart.
	Battery Wait for parallel	Flash	-	-	No action necessary. This battery will join in parallel within 1 cycle.
Charge	Total overvoltage alarm	•	-		stop charge
Charge	Total overvoltage protection	-	•		stop charge, start discharge
Charge	Cell over-voltage alarm	•		-	stop charge
Charge	Cell over-voltage protection		•	-	stop charge

RUNNING STATE	STATUS	RUN	ALM	DISPLAY	SOLUTION
Charge	over current alarm	•	-		lower the power used
Charge	over current protection	-	•		disconnect the battery and turn it on after lowering the power
Discharge	total low-voltage alarm	•	-		start charging
Discharge	total low-voltage protection	-	•		charging activation
Discharge	cell low-voltage alarm	•	-	-	start charging
Discharge	cell low-voltage protection	-	•	-	charging activation
Discharge	over current alarm	•	-		lower the power used
Discharge	over current protection	-	•		disconnect the battery, stop using the battery, and reset BMS once within a safe range
Temperature	charge over-temperature alarm	•	-		reduce the environment temperature, lower the power used
Temperature	charge over-temperature protection	-	•		disconnect the battery, stop using the battery, and reset BMS once within a safe range
Temperature	charge low-temperature alarm	•	-		reduce the environment temperature
Temperature	charge low-temperature protection	-	•		disconnect the battery, stop using the battery, and reset BMS once within a safe range
Temperature	discharge over-temperature alarm	•	-		reduce the environment temperature
Temperature	discharge over-temperature protection	-	•		disconnect the battery, stop using the battery, and reset BMS once within a safe range
Temperature	discharge low-temperature alarm	•	-		improve the environment temperature
Temperature	discharge low-temperature protection	-	•		disconnect the battery, stop using the battery, and reset BMS once within a safe range

RUNNING STATE	STATUS	RUN	ALM	DISPLAY	SOLUTION
Temperature	environment over temperature alarm	•	-		reduce the environment temperature
Temperature	environment over temperature protection	-	•		reduce the environment temperature
Temperature	environment low temperature alarm	•	-		improve the environment temperature
Temperature	environment low temperature protection	-	•		improve the environment temperature

6.1 Introduction

This document provides step-by step instructions on basic maintenance and repair procedures for the eVault Max battery. This guide is supplemental to the installation manual.

Warning!

- The user of this guide must have a thorough understanding of good installation practices before attempting disassembly of the unit.
- Warning notices on the installation manuals must always be read.
- All necessary safety precautions must always be taken when performing work on 48V batteries.

6.2 Preliminary Actions

- **Make sure to wear appropriate PPE while performing any type of work on batteries.**
- Prior to disassembling the battery, isolate the battery. To do so, **disconnect the power and communication cables from the battery.**

6.3 Removing Front Panel

The front aluminum panel is held in place by eight (8) Phillips screws (see below).

1. Remove the screws.
2. Slowly and gently separate the front panel from the battery.

Warning: Take care not to over-extend the wires connected to the LED board and the screen.



6.4 Removing Dead-Front

Once the front panel is removed, the internal elements of the battery will be visible. For safety reasons, there is a transparent dead-front covering these elements (see below).

- Remove the six (6) Phillips screws that support the dead-front.



7.1 Updating Firmware

NOTE: It is important to disconnect the battery-battery communication and battery-inverter communication cables from the system to update firmware.

When the firmware is updating, the eVaultMax will shut off.

If there is power to or from the system during an upgrade severe damage may occur.

Downloading firmware from the Fortress power website is necessary to update the battery's firmware.

1) Open The eVault Max BMS Tool software "eVaultMaxUpperComputer.exe"
Application

The following Screen is the default UI display

2)Connect your modified Cat 5 cable to the Can tool

Pin Out:1 (greenwhite for type A or orange whitefor type B to Can H and 2 (green[A]or orange[B]) to Can L.

3)Connect your Cat 5 Header to the "COM Parallel" port on the eVault Max (In or Out –it is a common bus)

4)Select "USBCAN#" In the bottom left corner

5)Select "Open CAN-Bus" directly below the "Type" selection

A successful CAN pairing will display the battery parameters as seen below

6)Navigate to www.fortresspower.com/firmware and downloadthe latest eVaultMax Firmware to your local device.

7)Upon a successful download of the eVault Max firmware, navigate to the firmware tab in the navigation section of the BMS application

8)Open the "Select File" buttonabove the "Start"

9)Select the ellipsis button next to the "Update File" display box

Your file browser window will open.

10)Navigate to where you downloaded the firmware file and select the

"HEBMS#####PW##T.s19 file. It willhave a similar structure to the image below:

11)Click "Start"The eVault will turn off while the update is running.Do not disconnect the CAN Tool from the computer or battery while the update is running.The firmware update may take a few minutes. A progress bar will show the status of the update
A Successful firmware update will show like the window below:

12)Manually restart the battery (holding the power button for 10 seconds until the "status" light turns off)

13)The eVaultnow has the latest firmware. Verify by viewing the Firmware version display box

APPENDIX B. Installing the Drivers, Software, and Firmware 1.

Visit <https://www.fortresspower.com/resources/>

Download and uncompress/unzip the following files for your battery:

- a. Drivers for Canbus communication
- b. Additional Drivers for Canbus communication
- c. Software -either BMS.exe or BMSTool
- d. Firmware -*.bin files

2. Testing the computer connection to the CANbus tool before visiting the site saves valuable time. Install the drivers and then open the Cantest software. A successful CAN connection can be made just with the tool and a computer --no Fortress battery is necessary to test this step.

3. After downloading and uncompressing the first set of drivers, go to the Windows Device Manager by clicking the Windows button on the menu bar and typing "Device Manager". Make sure the Canbus tool is plugged into the computer.

4. Find the Canbus tool within the Device Manager list, it commonly appears in the USB devices or as an unidentified USB device. Select "Update Drivers" and then browse to where the drivers were downloaded -commonly the Downloads folder. Select the "Canbox driver" folder and press OK. You do not need to specify the 64 bit or 32 bit folder, simply selecting the "Canbox driver" folder will install the correct drivers.

5. Update the drivers.

6. Go to the Downloads folder and install the CANTest software which contains additional drivers commonly needed to CANbus communication (CANTest_Setup_V2.70).

- a. When the windows message appears, select "More info" and then "Run Anyway".
- b. You may need to respond to your anti-virus software alert, or even disable the anti-virus software for 10 minutes to install the software.
- c. After the software finishes installing, select "Y" to complete the process.
- d. You do not need to run the CANTest software. If it opens, go ahead and close it. This software is only installed for the extra CAN drivers.

C. Testing the Driver + Software before visiting Site

1. Go to the Downloads folder by clicking the "Folder" icon in the Windows menu and then selecting the Downloads folder. Find the battery software folder and open the appropriate software program. Here are the folder and software names for each battery.

2. Open the appropriate software and then connect to CAN software. You will see a CAN connection success message. See pictures below. If CAN has not connected, please reinstall the drivers and the additional drivers (Step B4-B6 and check the wired connections (Step A4).

7.2 Charging

This procedure is to be followed only when the battery voltage is ~48V or less.

To see where to connect the charger's alligator clips, refer to the figure below. The charger may be removed once the battery voltage exceeds ~50V.

Warning!

- Ensure correct polarity: positive to positive (red), negative to negative (black).
- Alligator clips must be connected to the battery prior to connecting the charger to the power-outlet. Always read the installation manuals.
- After the battery is charged, the charger must be disconnected from the power-outlet first.

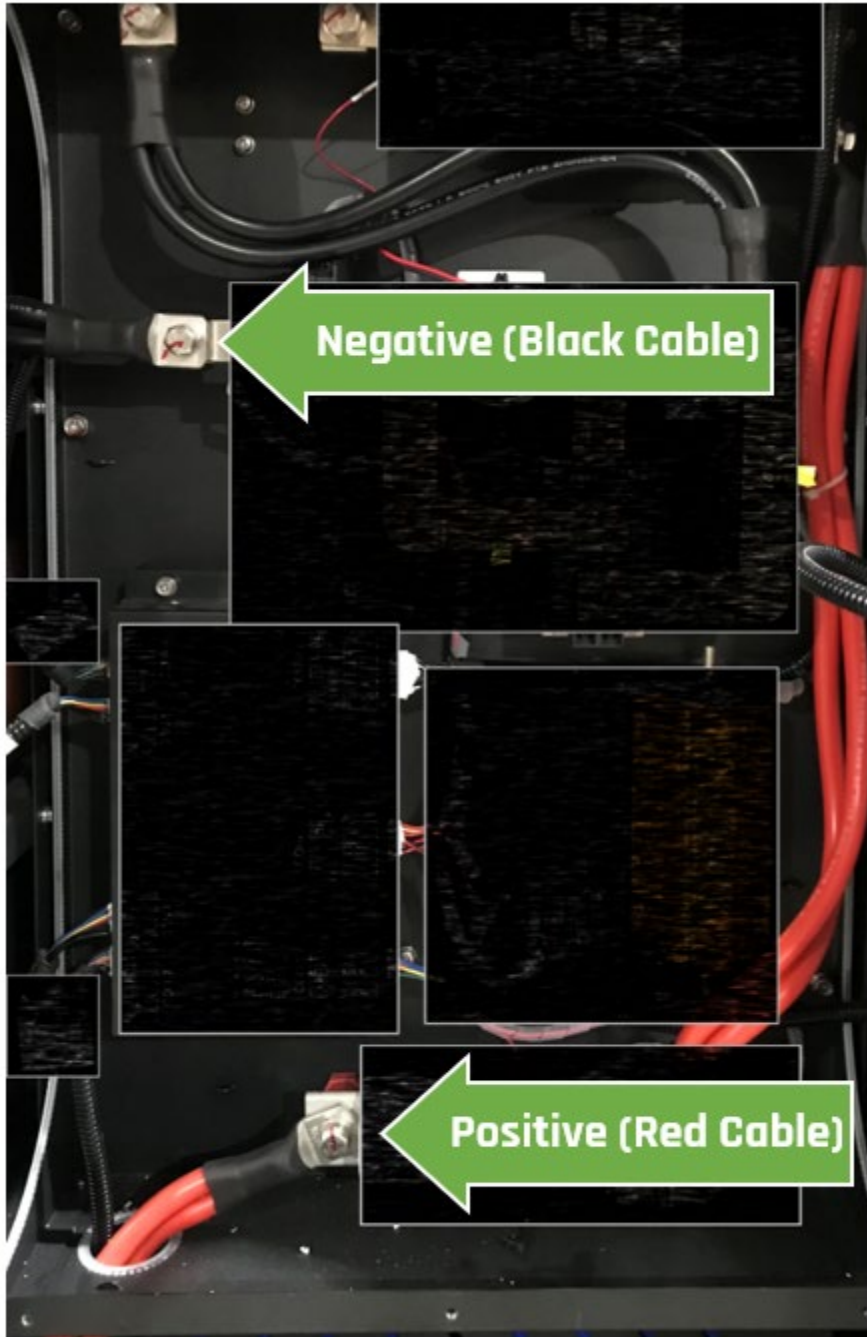

7.3 Replacing the Fuse

To remove the fuse, one must remove two (2) 13mm bolts. These bolts hold the fuse in place and ensure the electrical contact between the fuse and the power cables. Once the bolts are removed, the fuse is replaced and the steps prior to the fuse replacement are followed in the reversed order.

Warning!

- Wear electrical insulating gloves when performing this procedure.
- Once the fuse is removed, insulation (such as electrical tape) to the exposed ends of the removed cables. Only remove the insulation immediately before connecting the cables to the new fuse.
- Do not overtighten the bolts.

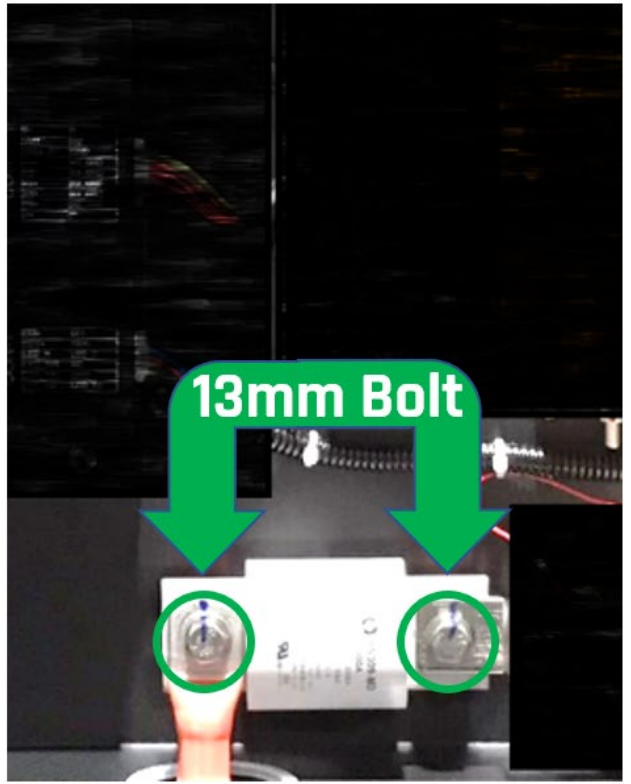
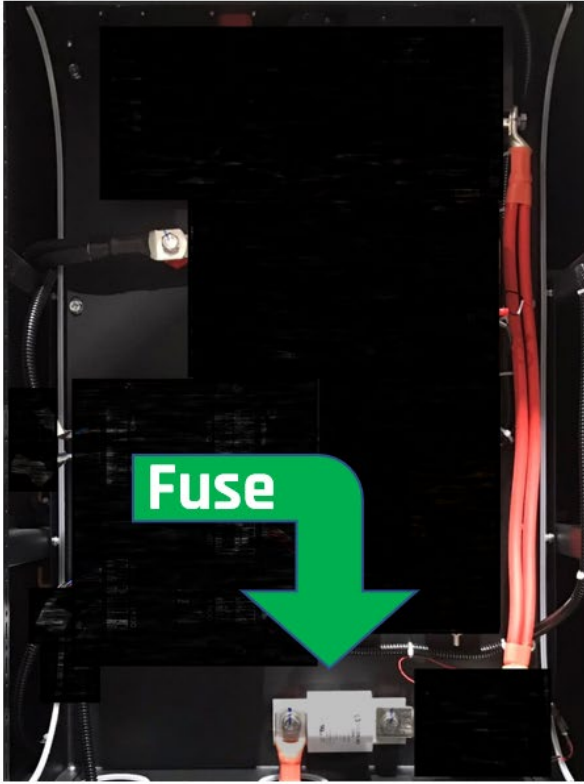

7.4 Replacing the BMS

The BMS is held in place by four (4) Phillips screws and has seven (7) connectors connected to it (see below). **Disconnect the connectors from the BMS, following the order shown on the figure below.** Next, remove the four (4) Phillips screws. Once the screws are removed, the BMS is replaced and the steps prior to the BMS replacement are followed in the reversed order.

Warning!

- Reconnect the connectors following the reversed order in which they were disconnected.
- Once the fuse is removed, insulation (such as electrical tape) to the exposed ends of the removed cables. Only remove the insulation immediately before connecting the cables to the new fuse.
- Do not overtighten the bolts.

